

Welches Berufs-feld passt zu mir?

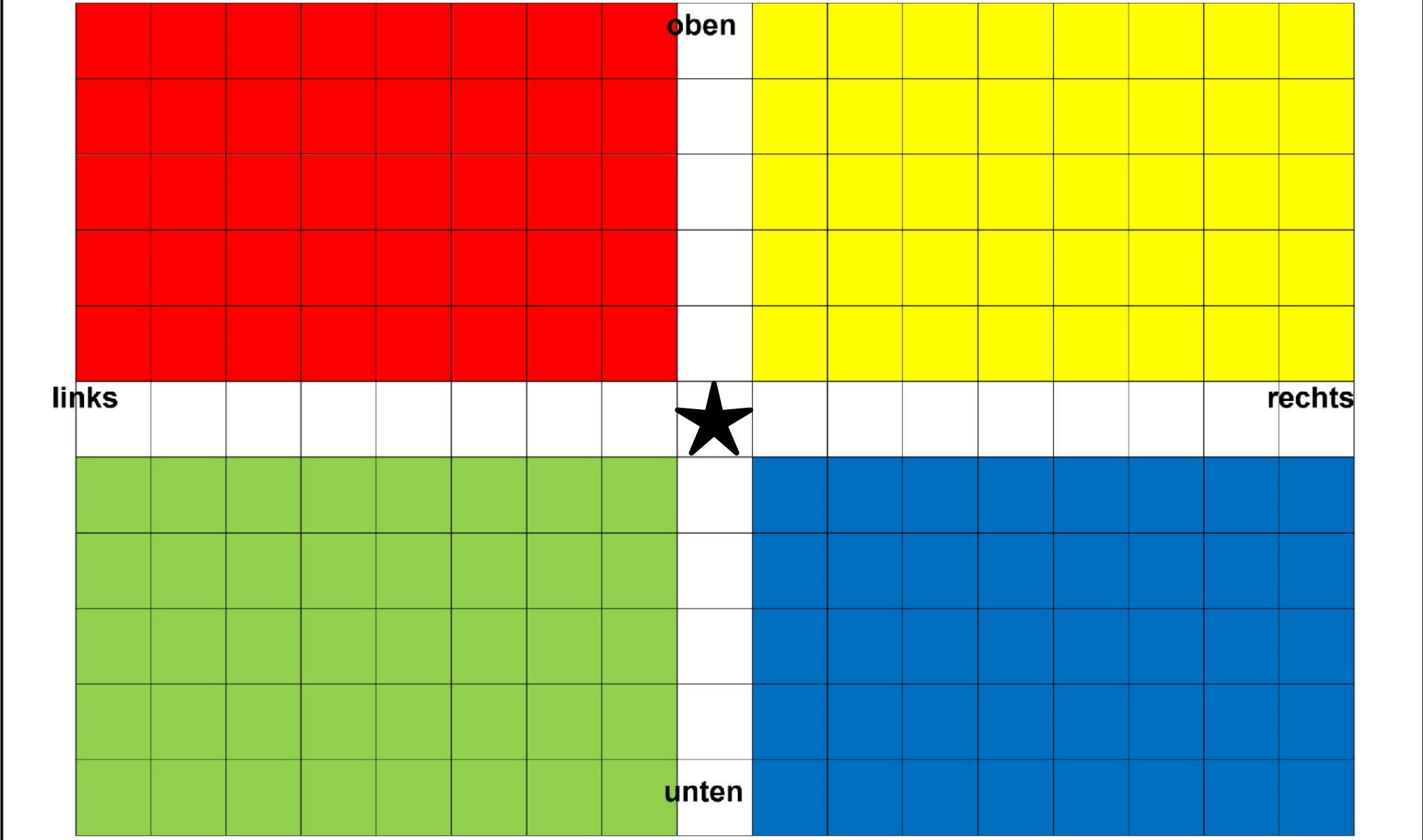

Frage 1



Ich möchte mit Menschen arbeiten.

Ja

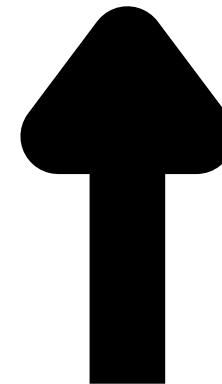

Nein

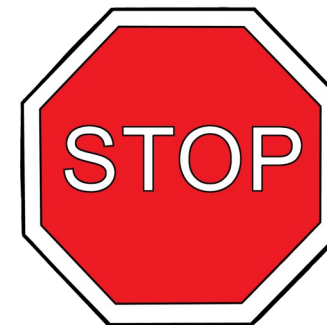

Frage 2

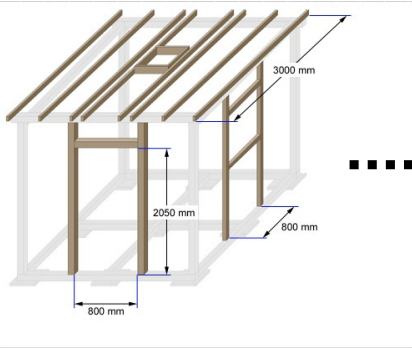

Du siehst eine Zeichnung von einer Sache.
Und du weißt:
So sieht die Sache in Wirklichkeit aus.

Ja

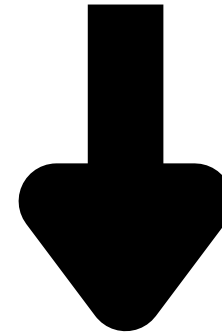

Nein

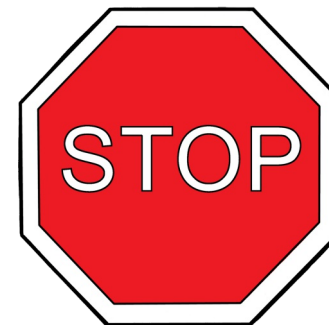

Frage 3

Ich kann körperlich arbeiten.



Ja

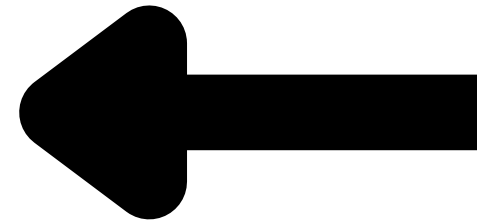

Nein

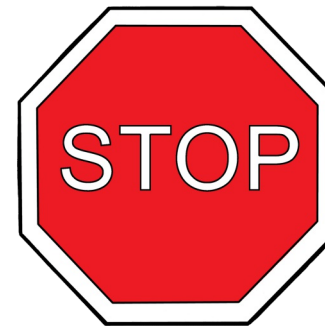

Frage 4

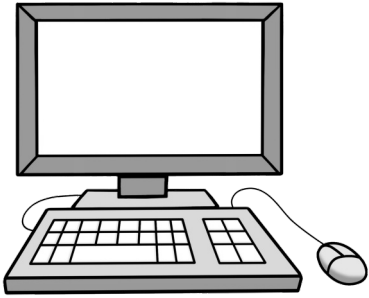

Ich möchte am Computer arbeiten.

Ja

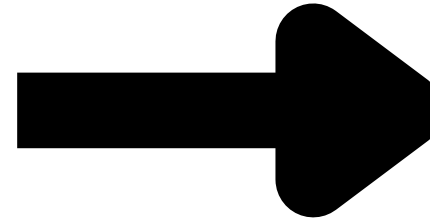

Nein

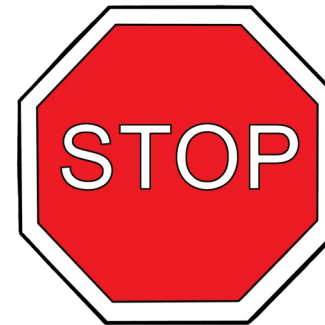

Frage 5

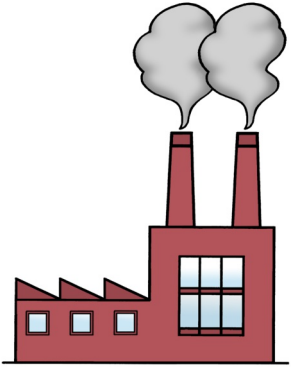

Ich möchte in einer Werk·statt arbeiten.
Oder ich möchte in einer Fabrik arbeiten.

Ja

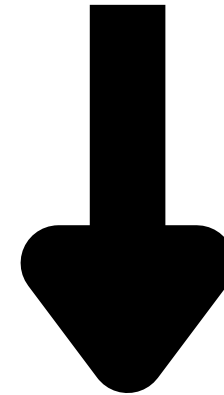

Nein

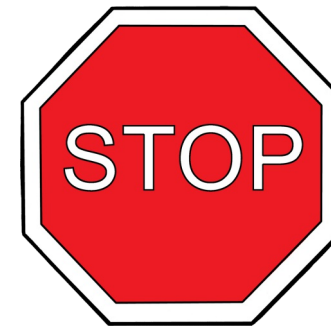

Frage 6

Ich kann gut mit den Händen arbeiten.

Ja

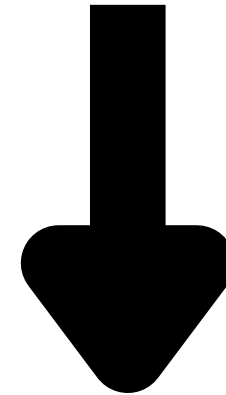

Nein

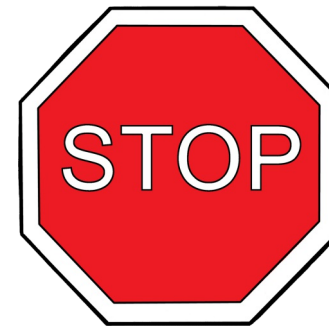

Frage 7

Ich kann meine Arbeit gut planen.

Das heißt:

Ich überlege mir:

Wann mache ich was?

Ja

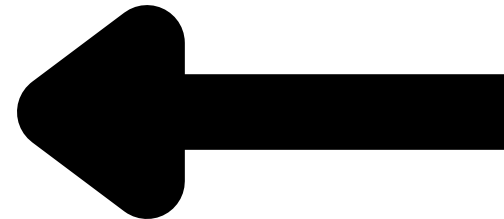

Nein



Frage 8

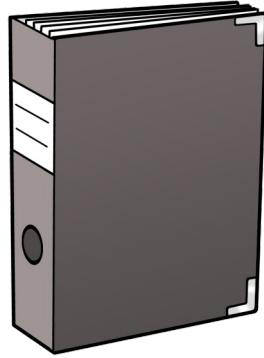
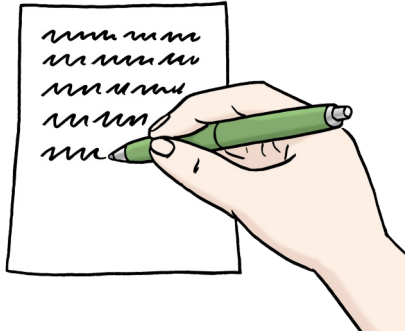

Ich möchte viel schreiben.
Und ich möchte mit Ordnern arbeiten.

Ja

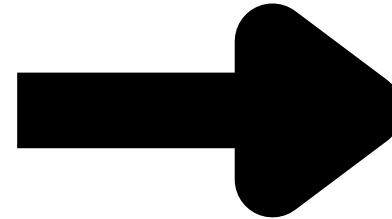

Nein

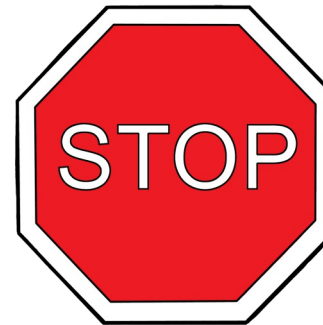

Frage 9

Ich möchte regel·mäßige Arbeits·zeiten haben.

Das heißt:

Ich arbeite **nicht** am Wochen·ende.

Und ich arbeite **nicht** in der Nacht.

Ja

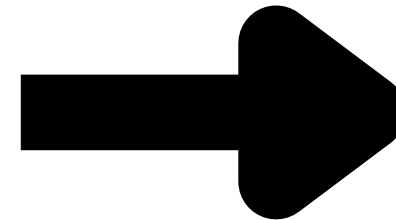

Nein

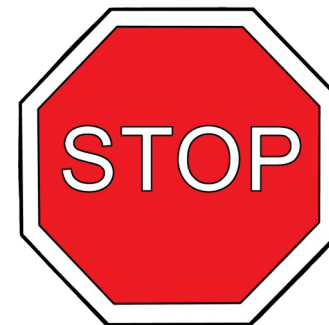

Frage 10

Das soll zu meiner Arbeit gehören:

- Physik
- Chemie
- oder Biologie.

Ja

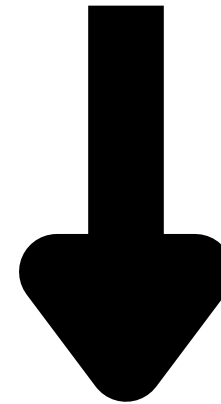

Nein



Frage 11



Ich möchte Sachen verkaufen.

Ja

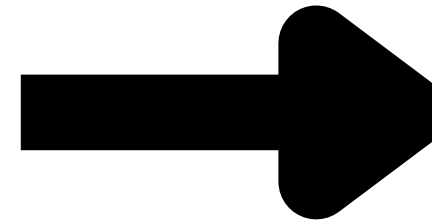

Nein



Frage 12

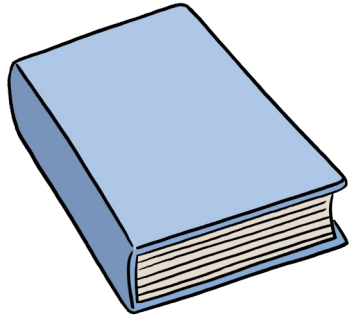

Ich arbeite gerne mit Texten.

Ja

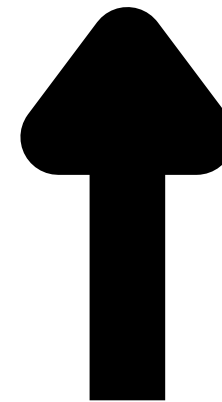

Nein



Frage 13



Damit möchte ich arbeiten:

- Steine
- Beton
- oder Holz.

Ja

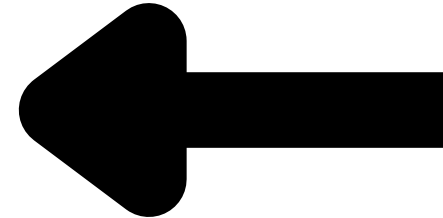

Nein

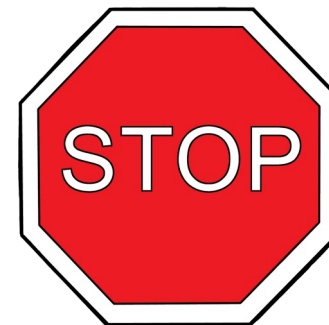

Frage 14

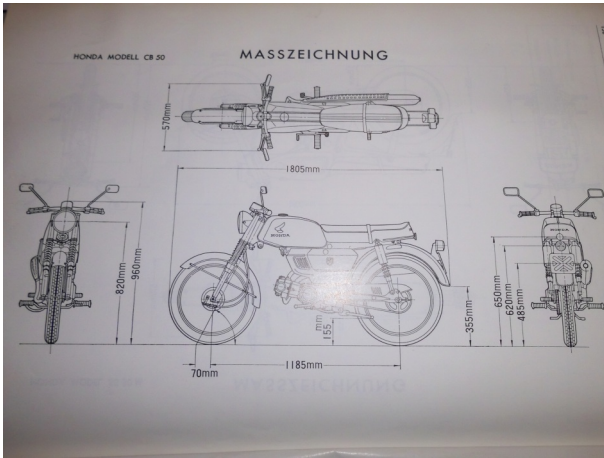

Ich möchte mit technischen Zeichnungen arbeiten.

Ja

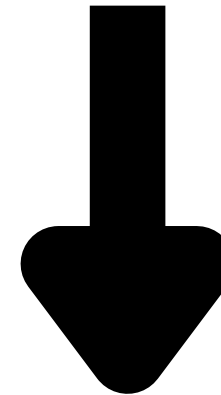

Nein

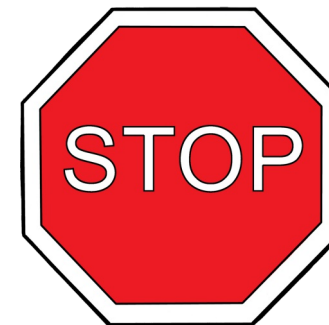

Frage 15



Das möchte ich machen:

- Sachen kaufen
- Sachen verkaufen
- und Menschen Tipps geben.

Ja

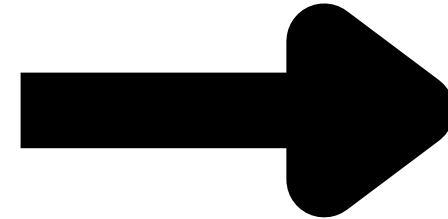

Nein



Frage 16

Damit möchte ich arbeiten:

- Glas
- Keramik
- Edel·steine
- oder Holz.

Ja

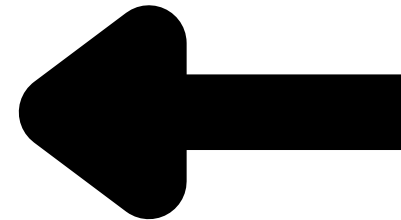

Nein

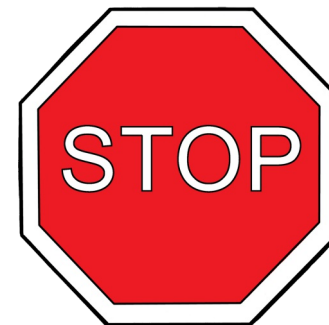

Frage 17

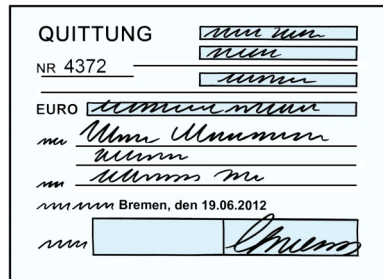

Ich kann gut mit Zahlen umgehen.

Ja

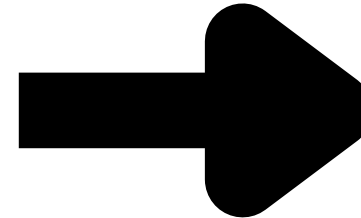

Nein

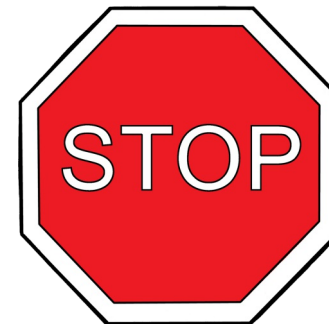

Frage 18

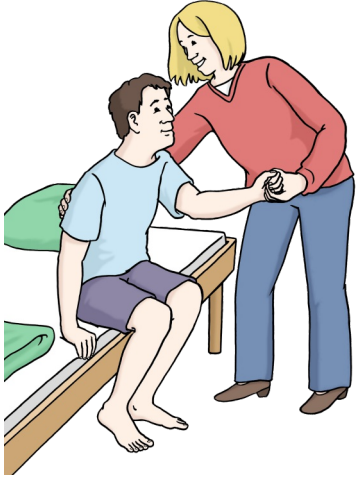

Ich möchte
mit kranken Menschen arbeiten.
Oder ich möchte mit behinderten Menschen arbeiten.

Ja

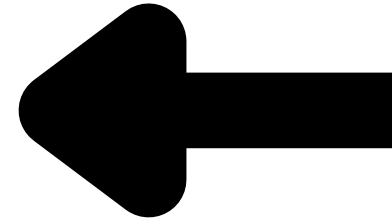

Nein

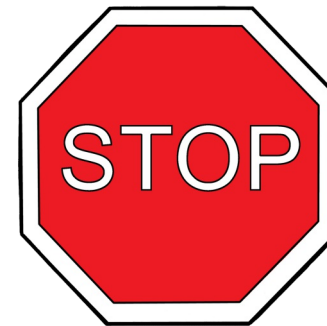

Frage 19

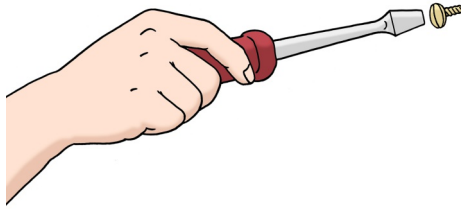

Ich möchte Sachen bauen.
Und ich möchte Sachen reparieren.

Ja

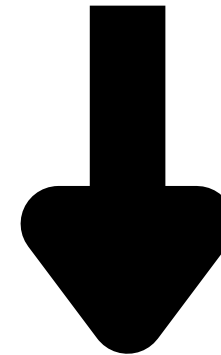

Nein



Frage 20

Ich plane gerne Dinge.

Das heißt:

Ich überlege mir:

Wann mache ich was?

Ja

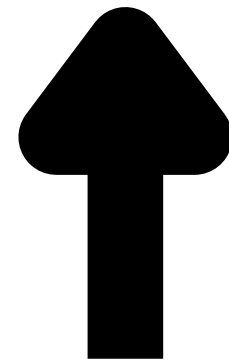

Nein

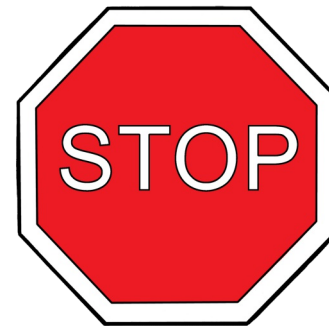

Frage 21

Ich möchte gerne mit Metall arbeiten.

Ja

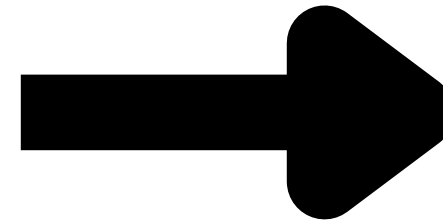

Nein

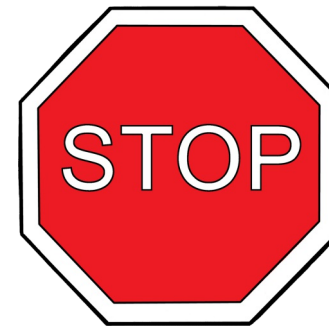

Frage 22



Das möchte ich machen:

- mich um Menschen kümmern
- und Menschen helfen.

Ja

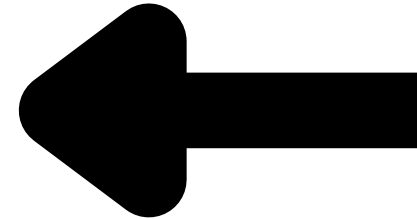

Nein



Frage 23

Ich möchte fremde Sprachen auf der Arbeit sprechen.

Ja

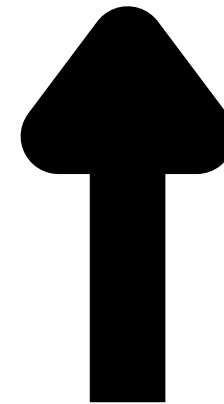

Nein

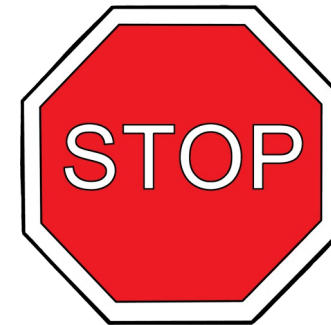

Frage 24

Ich kann einen kranken Menschen waschen.

Ja

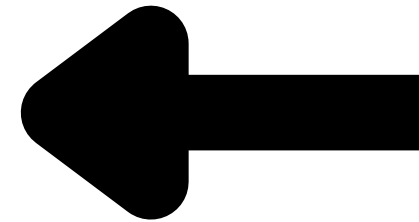

Nein

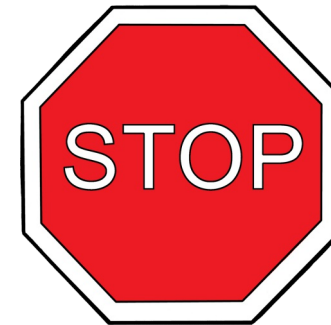

Frage 25



Ich möchte mit Maschinen arbeiten.

Ja

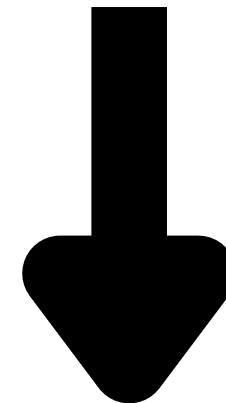

Nein



Frage 26

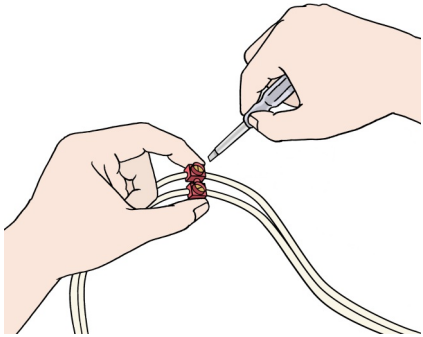

Ich möchte mit Elektronik arbeiten.

Zum Beispiel:

- Kabel
- und Schalter.

Ja

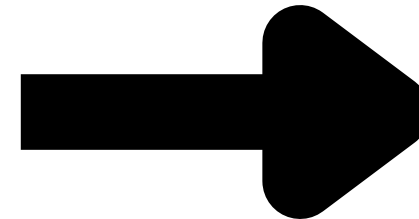

Nein

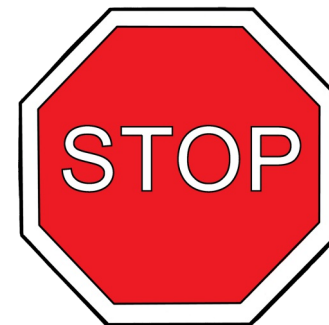

Frage 27



Ich möchte Menschen mit Gesprächen helfen.

Ja

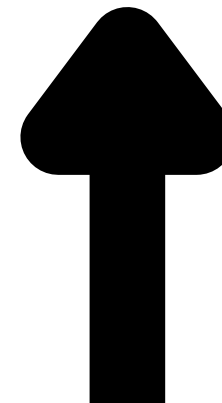

Nein

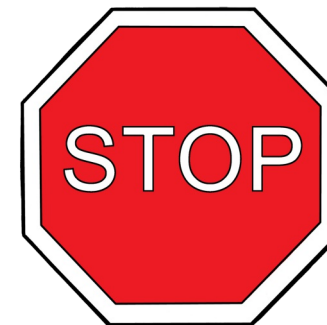

Frage 28

Ich möchte jeden Tag das Gleiche machen.

Ja

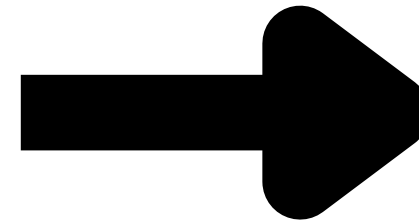

Nein

